

THE MARCH OF THE TOYS

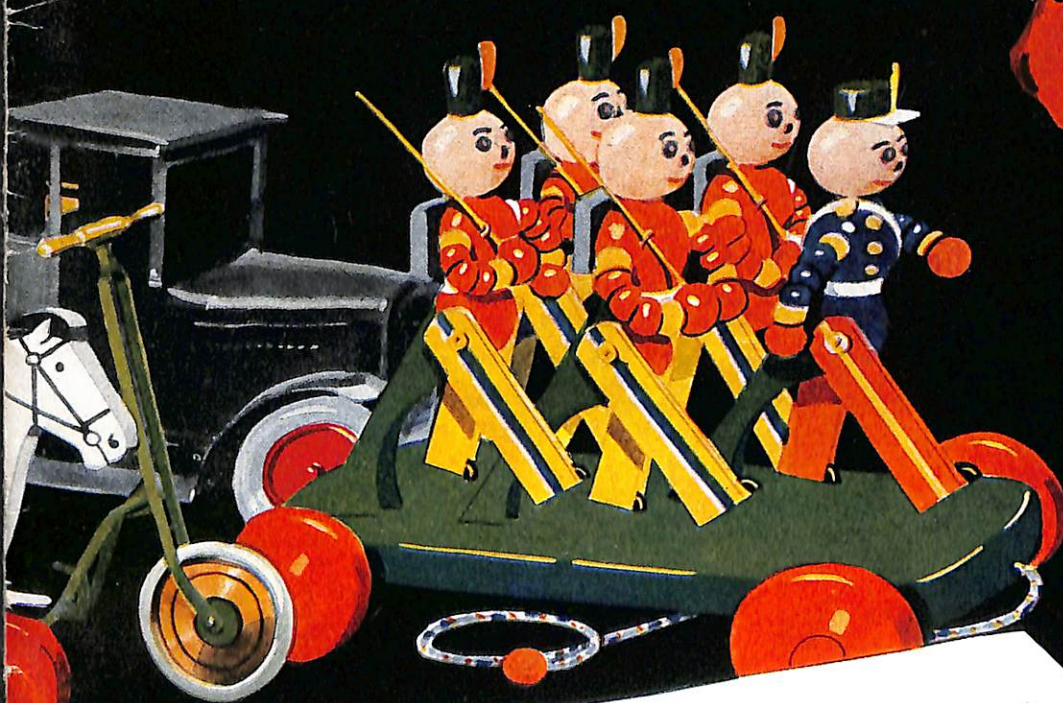

Merry Christmas from

H. WEHMHOEFER

Automobiles, Hardware, Plumbing and Heating
Telephone No. 18-R - - Beecher, Ill.

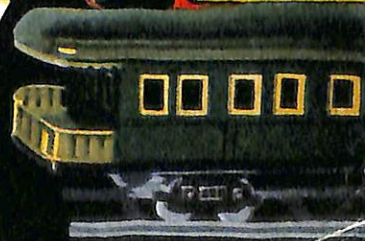
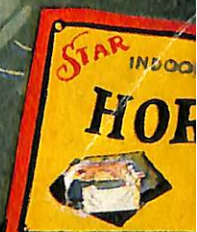
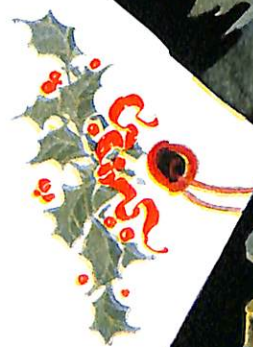

Hello/Folks

SANTA CLAUS
Again Opens His Bag For
You To Choose Your Gifts

“WHOA!—Dasher, Dancer, Prancer, Vixen, Whoa!” Here we are again! The bag is open. Take a peek inside and see what fine playthings we have for good girls and boys. Toys for the little tots; games, electric trains, speed skates, building sets, coaster wagons, educational play-

things— and what-not, for the older children. Look them over on the following pages. Then come in and see them in reality. Come in soon, before demand exhausts our supply.

Hibbard Hustler

ALL STEEL COASTER WAGON

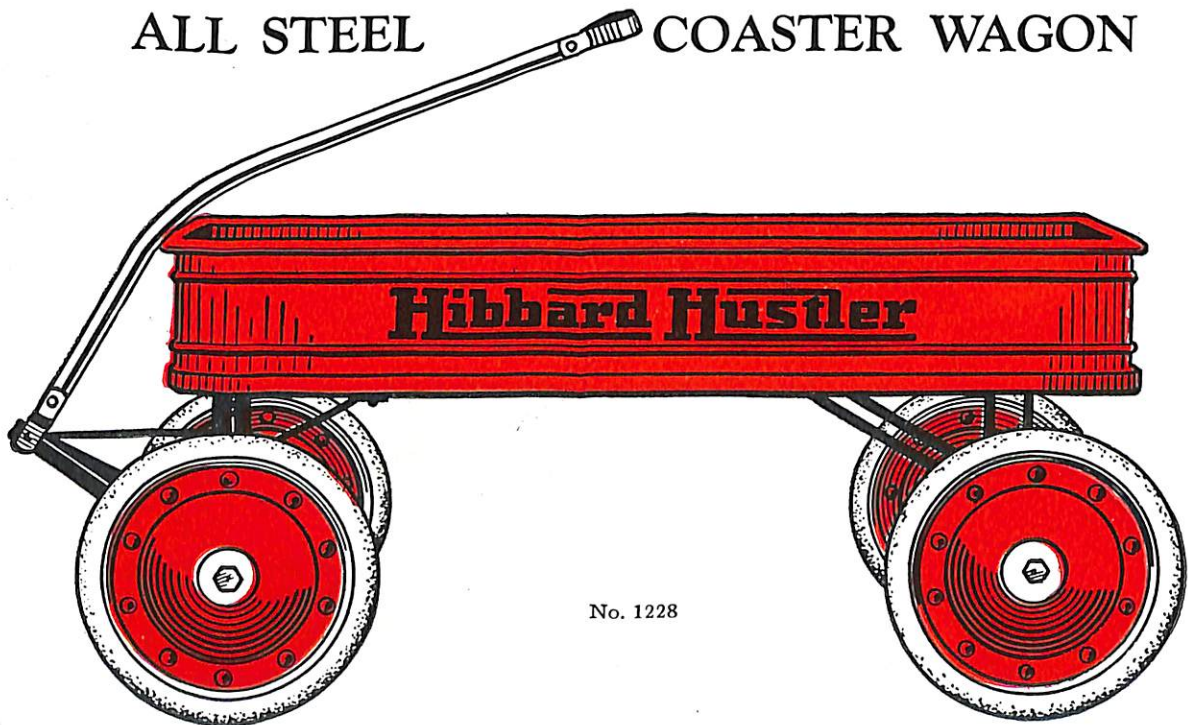

No. 1228

Here is a coaster wagon that all the boys and girls like. It is good to look at and will last a lifetime, even under ordinary hard usage. It is entirely built of stamped steel and is of most sturdy construction.

The wagon box has rounded corners and lock-seam bottom, so that it cannot possibly come apart. Wheels are heavy steel, double-disc type, riveted together. They have hardened roller bearings and highest grade rubber tires, wired on the wheels in deep channel, so that they will not come off at sharp turns.

Axles are extra strong and hubs are like those on automobiles; put on with special hub cap wrench which is furnished with each wagon.

The handle is of heavy steel and is placed to withstand severe jolts. It extends out in front far enough to enable the rider to steer with handle when coasting.

All parts have an attractive enamel finish, baked on to stay. Specially priced for the early Christmas buying season. Price..... **\$750**

Hibbard ALL STEEL RACER—

STRONG
STURDY
SPEEDY

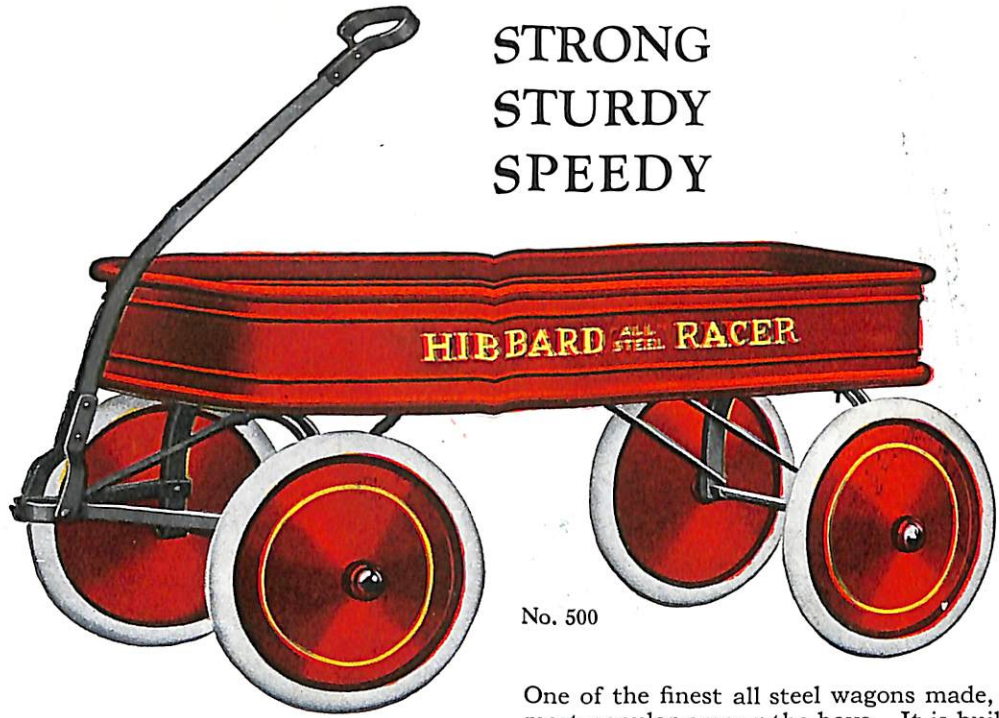

No. 500

One of the finest all steel wagons made, and one of the most popular among the boys. It is built for speed and great strength. Also, it is unusually handsome in appearance. It comprises many special features of construction which can better be appreciated upon close inspection.

The box, made of extra heavy steel, is removable, the detaching device being very simple and easily worked. Finished in bright red enamel, stenciled in gold.

Roller bearings; double-disc wheels, with corrugated rubber tires. The handle is of tubular steel, curved and equipped with loop grip.

Best all-around value on the market. Price

\$9.50

Hibbard ACE ALL STEEL COASTER WAGON

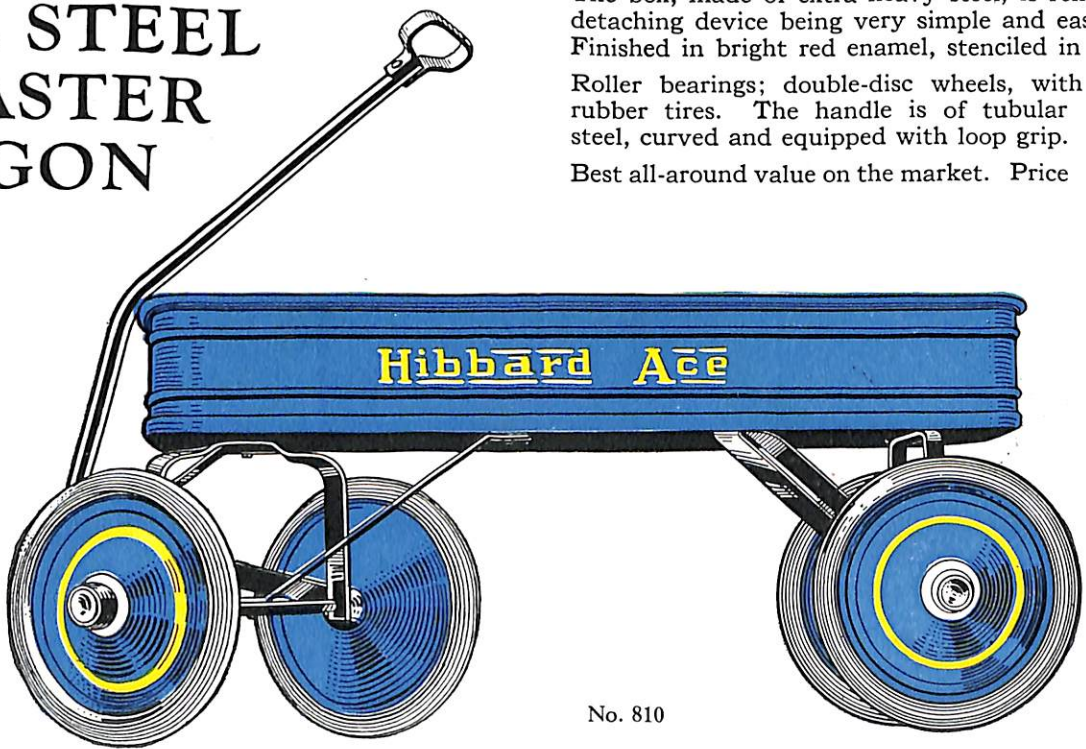

No. 810

An all steel coaster wagon that comprises most of the features of higher priced wagons, but we are offering it at a price that means quality at a bargain for you.

It is built to stand hard usage and the most severe tests. The box is made of high-grade 20-gauge steel. The bottom is beaded and reinforced with heavy steel plates in all places subject to strain. The undergear is of heavy channel steel construction, with large

axles, so formed as to stand up under great strains. The wheels are heavy, double-disc type, with roller bearings. Hub caps are easy to put on, but, when on, they stay on. The wheels have 3/4-inch rubber tires. Colorings of box, gears and wheels are very attractive. Come in and compare it with other steel wagons. You will be convinced of its excellent value. Price.....

\$7.00

BADGER SCOOTER

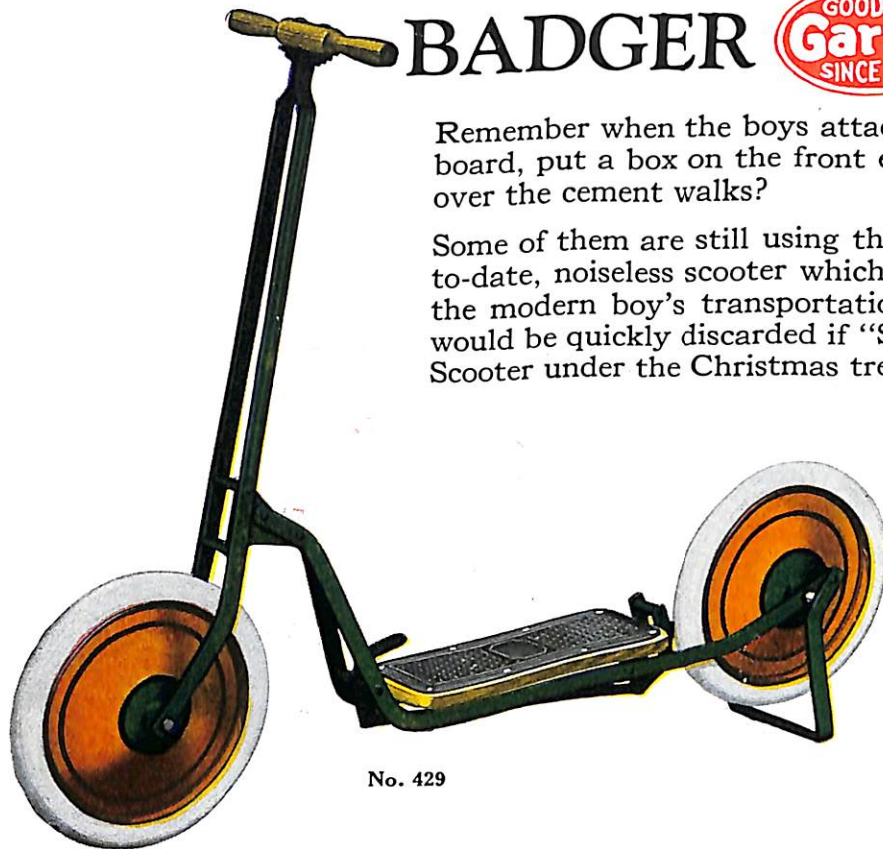

No. 429

Remember when the boys attached their roller skates to a narrow board, put a box on the front end and went speeding and roaring over the cement walks?

Some of them are still using that makeshift substitute for the up-to-date, noiseless scooter which is a most important possession in the modern boy's transportation equipment. But the makeshift would be quickly discarded if "Santa Claus" would leave a Badger Scooter under the Christmas tree.

The Badger Scooter is the "last word" in scooters. Although serving the same purpose—in a much safer and a noiseless way—as the boys' own invention, this modern adaptation bears little resemblance to its humble ancestor. It has double-disc wheels, with roller bearings and 1¼-inch high-grade rubber tires. It has a heavy steel frame, with sturdy parking stand and positive action roller brake. Finished in enamel. Footboard has non-skid rubber mat.

Price,..... **\$500**

~ BLUE RIBBON PLAY CARS ~



No. 70

Old Santa couldn't bring the little tots a present that would please them more. And the play cars mean safe, healthful exercise for them, out in the open air and sunshine. Whether they use pedals or just their own little legs for propulsion, they are constantly strengthening muscles and having a lot of fun doing it.

DAPPLE GRAY

This is a model that greatly pleases the kiddies because of the horse's head and handle-bar combination. The head is of cast aluminum, hand-painted dapple gray. The pedal wheel has ball bearings and the whole car is built strongly to stand hard usage. Wheels have rubber tires. Enamelled in red, black and yellow—baked.

Price **\$550**

The big mechanical feature of Blue Ribbon Play Cars is the swivel joint of exclusive design, in which steel operates against steel. This eliminates swollen and sticking joints, as is the case when wood is used. Has long wearing qualities; cannot wobble or come loose.

PITTY PAT

Similar in construction to "Dapple Gray," shown above, but without horse's head and pedals. The handle bar and post are nickel plated. Seat is red baked enamel. Wheels are red baked enamel, with yellow striping. Undergear and fork are black baked enamel. Handgrips are gray rubber. This is a dandy car for the very tiny children, and is excellent value at the price we are making at this time.

Price.....

\$350

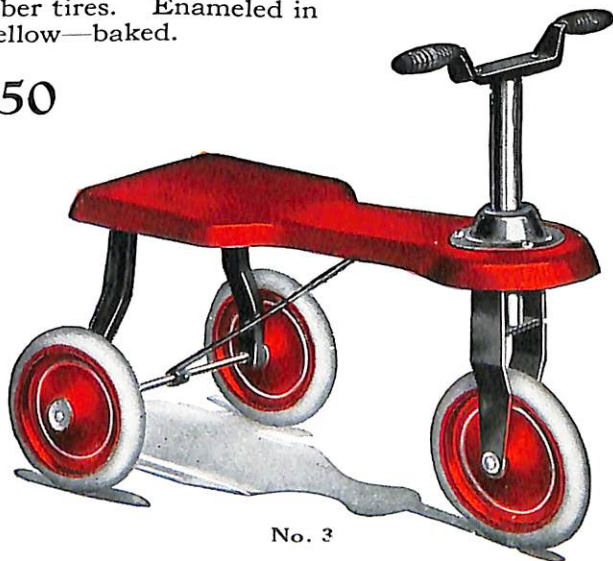

No. 3

DeLuxe Baby Walker and Stroller



This is not a toy, although it provides amusement for baby while mother pulls or pushes her infant along paths and sidewalks with a minimum of effort. The flat steel handle folds and is easily attached to front or rear. Steel foot rest provides comfort for baby's feet. Rubber-tired wheels guard against jolts and jars, as do the front and rear bumpers, also covered with rubber. Incidentally, the bumpers prevent marring of woodwork and furniture, when baby decides to use the Walker as a "kiddie-car" in the house.

The DeLuxe has a comfortably shaped back made of ivory enameled steel, with rubber covered support to hold baby. Double-disc steel, blue enameled rear wheels, with 1/2-inch rubber tires and 2 1/2-inch front swivel wheels, with 3/8-inch rubber tires. Wide comfortable seat finished in baby blue enamel. Undergear enameled blue. Folding handle is enameled black. Very good value.

Price \$450

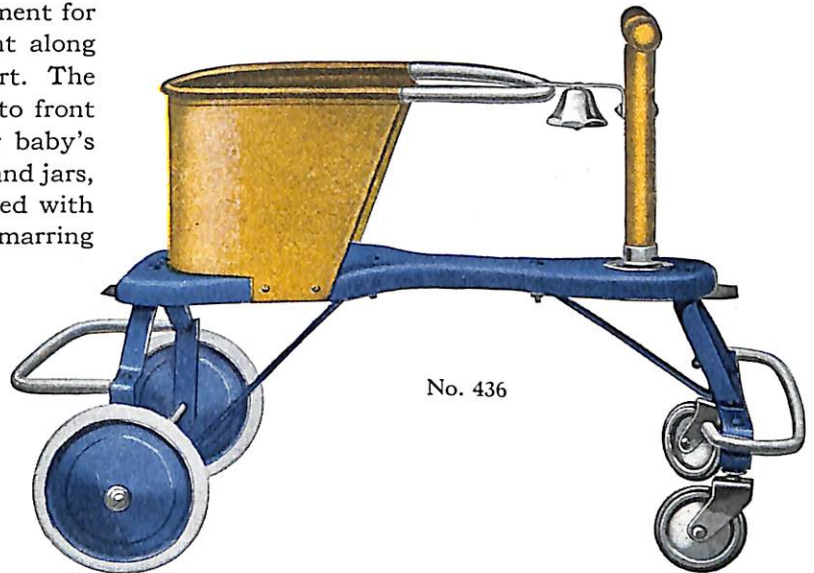

No. 436

BUDDIE BIKE—For Children from Two to Four Years

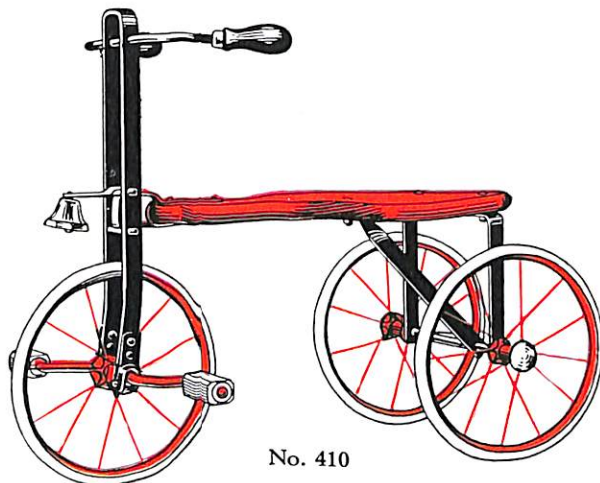

No. 410

This is an unusually practical toy vehicle which can be used as a velocipede, as it is equipped with pedals, or can be operated by pushing with the feet on the ground. It is strongly built; attractively finished and designed. Steel spoke, rubber-tired wheels, all enameled in colors.

This is one of the most popular toys ever made for the little tots. They delight in running about on it until the growing legs have to be thrust out beyond the handle bars.

Seat, pedals and wheels finished in red; gear black baked enameled; handle bar grips black enameled; handle bar, bell and hub caps bright tin plated; 1/2-inch rubber tires.

Price \$225

Excellent Value in This VELOCIPEDE

BUILT FOR COMFORTABLE RIDING AND EASY OPERATION

To the child a velocipede is as much a "necessity" as father's auto is to him, or a cookstove is to mother. He **MUST** have some sort of mechanical locomotion. He, too, likes to feel the swirl of the breeze created by his speed.

A healthful toy, is the velocipede. It keeps the child out in the open air and gives him general exercise and leg strength. The one shown above is of modern construction. Frame of iron; wire wheels, rubber-tired; adjustable handle bars; springs under saddle, which also is adjustable. Frame and forks well enameled.

Price \$750

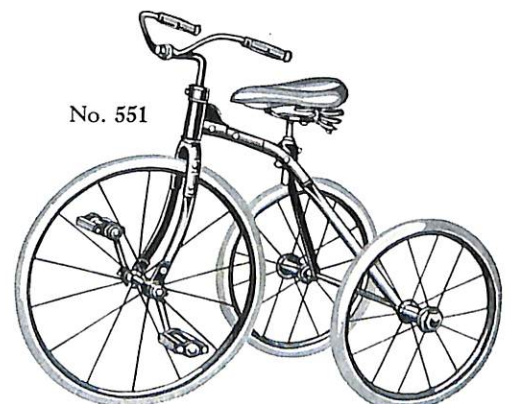

No. 551

STEELCRAFT JUVENILE AUTOMOBILES



No. 300

FIVE-TON MACK DUMP TRUCK

Boys, this is "the berries" and no mistake. It is not a toy that you have to push around and pretend that it is a man-size dump truck. It is big enough for you to sit in and operate just like a big Mack truck. You can haul dirt in it and dump the load. No "baby" stuff about this truck. It is made out of heavy steel, has springs, adjustable pedals, and a patented dumping mechanism. It is finished in red baked enamel and looks like a "million dollars."

Price, \$3500

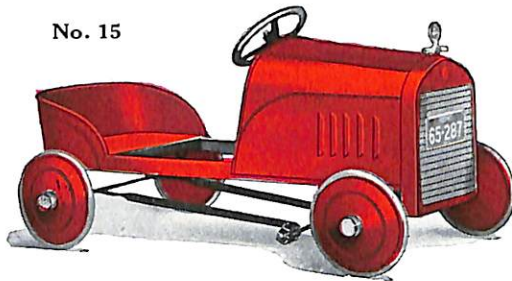

No. 15

FORD

For Children from 2 to 5 years

Here is a car especially suitable for the small child. It is moderately priced, but is high in quality of material, design and workmanship. It is 31 inches long and 21 1/2 inches wide. Equipped as illustrated. Drive, plain crank pedal. It has 8 1/2-inch double disc wheels, with 1/2-inch rubber tires.

Price, \$1200



No. 42

DODGE FIRE CHIEF

This is a small-size edition of a real fire chief's car. Any little girl or boy owning this flashy red speedster will be the envy of the neighborhood. It has bumper, steel fenders, steel running boards, springs, adjustable pedals, and large nicked bell with pull cord. Wheels are 10-inch double disc, with 1/2-inch rubber tires.

Price, \$1750

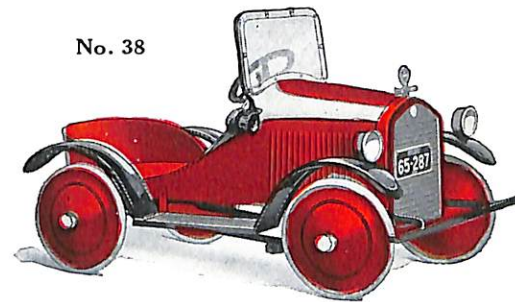

No. 38

DODGE ROADSTER

A trim, neat, racy, little car; one that any child will be proud of. It has springs, adjustable pedals, bumper, windshield, horn, motometer, designed instrument board, etc. It measures 38 inches long over all, and is 21 1/2 inches wide. The wheels are 10-inch double disc, with 1/2-inch rubber tires.

Price, \$1800

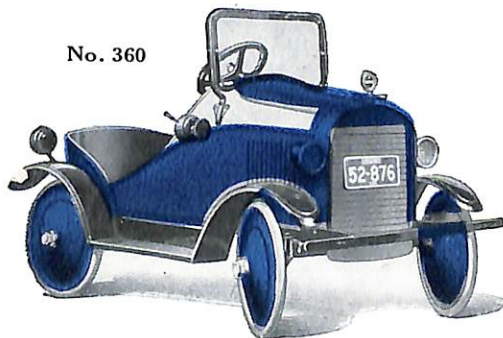

No. 360

CHEVROLET

A fine car for children from 3 to 7 years of age. It has bumper, steel fenders, steel running boards, adjustable pedals, springs, windshield, etc., as shown in the illustration. Wheels, 10-inch double disc, with 1/2-inch rubber tires.

Price, \$1900

Strength and durability are outstanding features of Steelcraft Juvenile Automobiles. They are noted, too, for their beauty of design. They are built throughout of heavy stamped automobile body steel. Enamels are baked on—not painted.

ARCADE TOYS "They Look Real"

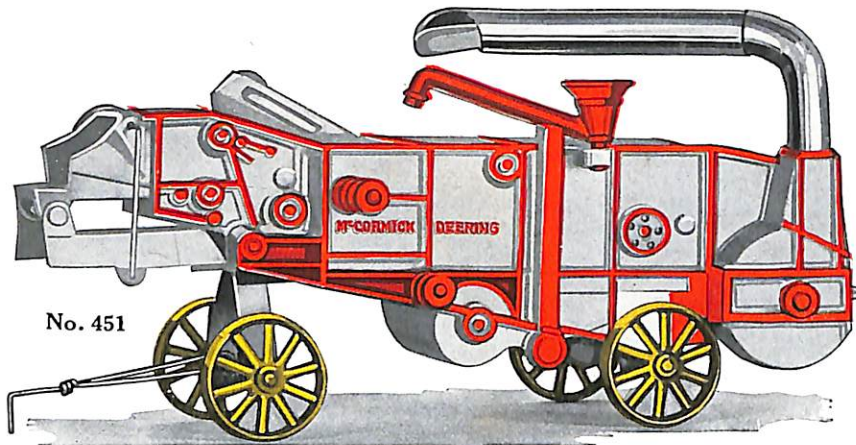

No. 451

These toys are just like the big machines that men drive, except that they are smaller. They are made of iron and are built to last many years. They work perfectly, and do the things for which their man-size models are intended.

Toy McCormick-Deering Thresher

Here is a toy that has no equal. So far as we know it is the only working miniature model of a man-size thresher. It is 12 inches long, 3 3/4 inches wide and 4 1/2 inches high; and you should see it in operation! Works just like the real thing. By all means, come in and see it. It's a wonder!

Price, \$2.00

Red Baby Truck

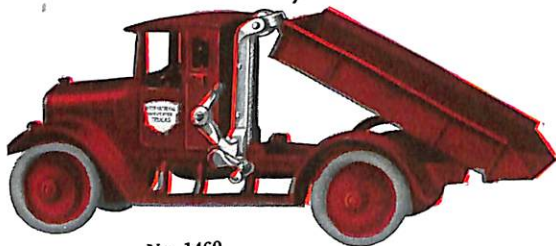

No. 1460

An International model dump truck that duplicates the work of a big one, in miniature. Must be seen to be appreciated. Price..... \$1.25

Buick Sedan

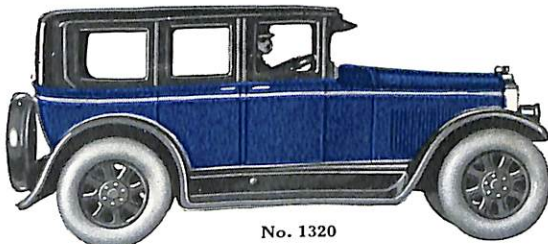

No. 1320

The illustration above tells its own story. Sturdily made of cast iron. Radiator and headlights are aluminum bronze. The word "Buick" is on radiator and tire carrier. The sedan is 8 1/2 inches long. Regularly equipped with nickel-plated rubber tires. Price..... \$1.50

Mack Dump Truck

No. 10

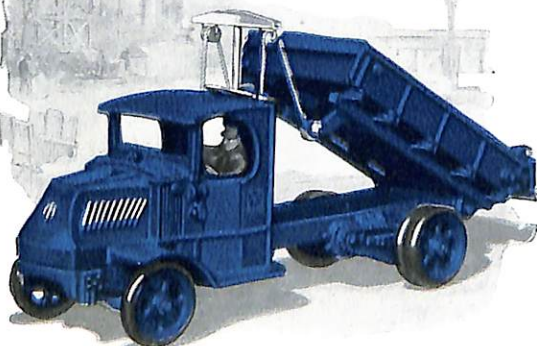

Looks and works just like a real Mack Dump Truck. Rubber tires. Dump body raised by clever, simple hoist. Press spring at rear of cab and the body rises by means of pulleys and ropes. Trip lock automatically throws rear end gate open. Price..... \$2.75

Toy Fordson Tractor

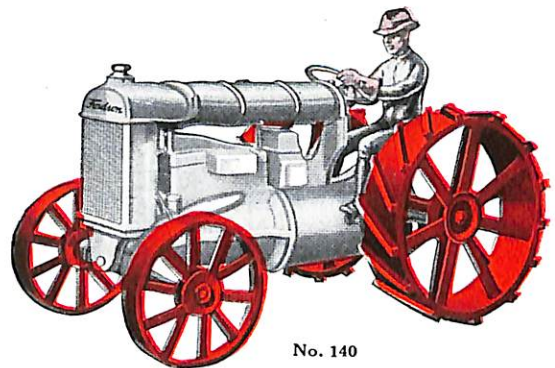

No. 140

Hundreds of thousands of these have been sold. Sturdily built and practically unbreakable. Front wheels and axles are mounted on swivel. No clockwork to get out of order. Price.. 50c

Ford Weaver Wrecker

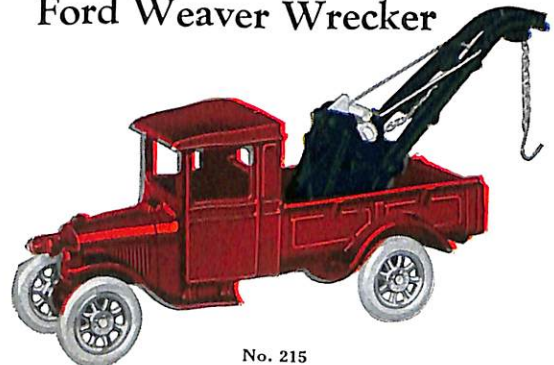

No. 215

Again the illustration tells, better than words, the description of this wonder toy. It is made to give efficient service as a wrecker, and the boys can give actual service to the other children who have automobile "troubles." Price..... \$1.00

Mack Fire Truck

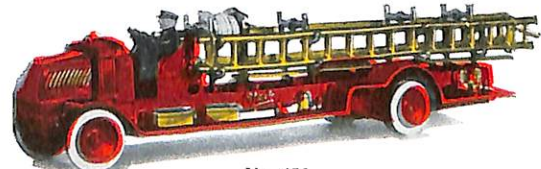

No. 456

Finished in bright red enamel. Ladders, lanterns and tank are finished in gold bronze. Ladder supports, hose reel and driver are nickel-plated and the tool boxes are trimmed in gilt and black enamel. A fire bell beneath the truck rings when the car is in motion. Ladders are removable and can be extended to any height desired. Fire hose unwinds from the reel. Price..... \$4.00

CONCRETE MIXER

(It Really Mixes Concrete)

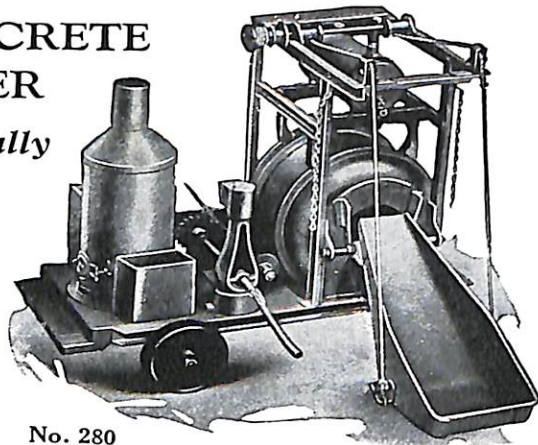

No. 280

The Concrete Mixer actually mixes concrete. By means of Buddy "L" forms, the young contractor can make concrete roads, bridges, bird baths, blocks, etc. The Mixer is 16 inches long, 13 inches wide and stands 15 inches high. You should see it in operation. Price..... **\$12.75**

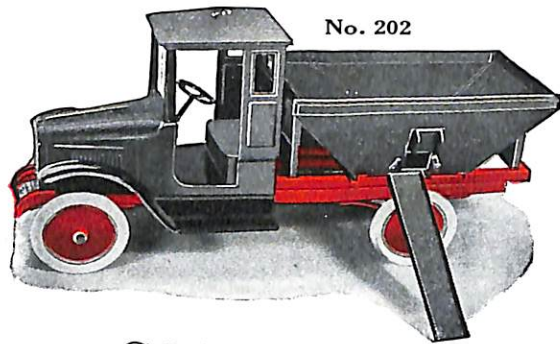

No. 202

COAL TRUCK

Just like the real thing. City type coal body, with hinged trap-door on each side with catch. Detachable steel chute for "side-walk delivery." Enameled red and black. Is 25 inches long, 12½ inches high and weighs about 25 pounds. Price..... **\$7.50**

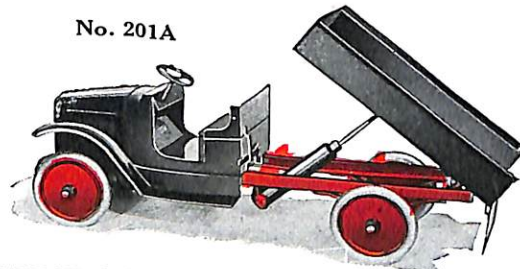

No. 201A

HYDRAULIC DUMP TRUCK

Standard chassis. Body raises automatically upon releasing lever. Drop end-gate. Aluminum wheels. Enameled red and black. Price..... **\$7.50**



No. 204A

RAILWAY EXPRESS

This truck has a standard chassis, heavy screen side body, drop end-gate, and double rear doors with Corbin padlock. Enameled green, red and black. 25 inches long and 12½ inches high. Price..... **\$7.50**

BUDDY "L"

STEEL PLAYTHINGS

Toys used to be flimsy things that broke easily. Then came Buddy "L" indestructible steel toys, and they sprang into quick and wide popularity. They are large enough for use like the man-size trucks, derricks, steam shovels, etc., of which they are replicas.

No. 205



FIRE TRUCK

This truck has six feet of extension ladders, with windlass for elevating. There are 20 feet of sash cord hose. Brass railings, brass bell, and wrecking crane attachment. Enameled brilliant red. 27 inches long and 12 inches high. Price..... **\$8.75**

DUMP TRUCK

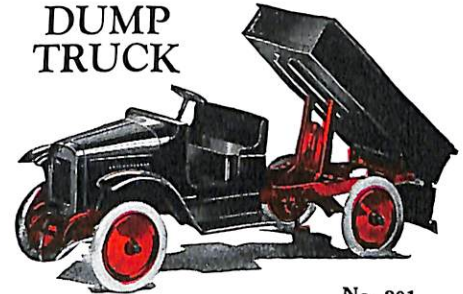

No. 201

The dumping device operates by a windlass and chain. Ratchet holds body at any elevation. End-gate drops to release the load. Length, 25 in.; height, 9¼ in. Price..... **\$5.25**

No. 220



STEAM SHOVEL

Works just like the big ones you see on excavations. It scoops up the dirt and elevates it, then swings clear around and drops the load at any desired spot. Enameled red and black. Is 25¾ inches long and stands 13 inches high. Price.. **\$3.25**

ICE TRUCK



No. 207

Has special chassis and fenders. Big, roomy body. Rear step with handrails. Cross chain and sliding canvas cover. Body enameled yellow; chassis, red; cab, black. Length, 26½ inches; height, 12½ inches. Price..... **\$7.50**

These Toys are made just like man-size models and work like them as well.

REAL ELECTRIC STEAM ENGINES

Empire Engines have steam whistles smoke-stacks, water gauges, throttles, safety valves and **SPEED!** They operate by steam and hot air, and are heated by electricity. They have

lots of power and will drive all kinds of mechanical toys. Can be throttled down to any speed. Electric light socket and cord with each engine.

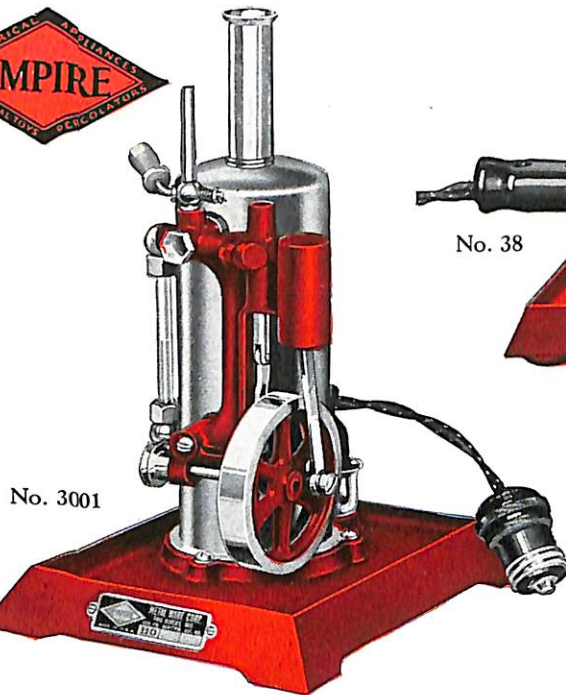

No. 3001

EMPIRE VERTICAL STEAM ENGINE

This is a real, power producing engine—not merely a toy built so that the boys can see the “wheels go round.” It will drive mechanical toys. Generates steam in a boiler of seamless drawn copper, highly nickel-plated. Electrically heated, eliminating all danger from fire. It has a throttle, steam whistle, fly-wheel, smoke-stack, safety valve, water gauge, red cast base and brass running parts, all accurately machined. Price..... **\$12⁰⁰**

Empire Electric Steam Engines are Guaranteed Mechanically Perfect. They are listed as Standard by the National Board of Fire Underwriters.

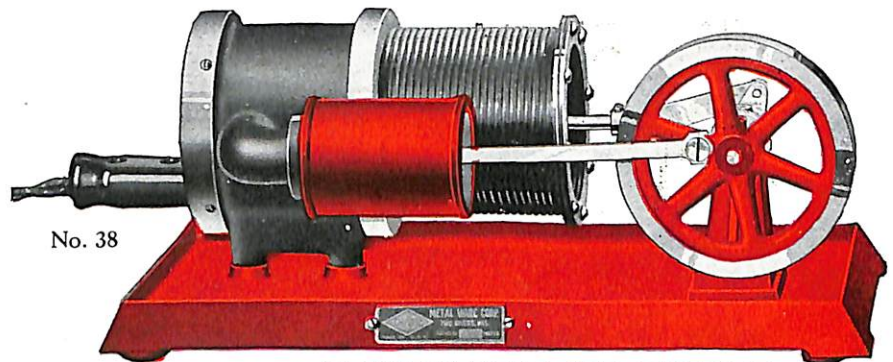

No. 38

EMPIRE HOT AIR ENGINE

This engine develops unusual power and runs for hours without attention, except an occasional oiling. Operates on standard electric light socket. All parts are accurately machined. Has a fly-wheel, red cast base and brass running parts. Price..... **\$15⁰⁰**

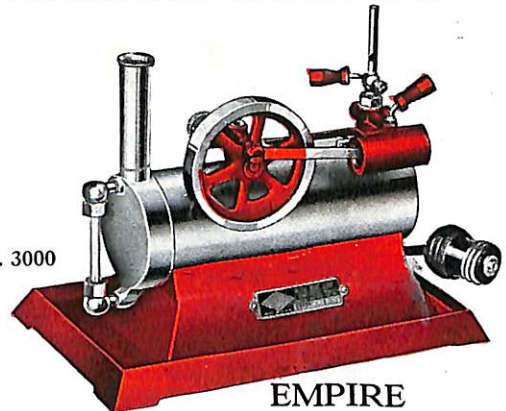

No. 3000

EMPIRE HORIZONTAL STEAM ENGINE

This engine corresponds exactly to the vertical engine shown and described at the left, except that it is built horizontally instead of upright. It has the same specifications—just made this way because some boys prefer this type to the other. Price..... **\$12⁰⁰**



No. 27

An instructive and practical plaything for girls of all ages—from the youngest to those approaching adolescence. An exceptionally fine “toy” that will provide amusement and education to succeeding youngsters in the family, through their years of growth. No. 27 Price..... **\$12⁰⁰**

A MINIATURE ELECTRIC RANGE THAT COOKS AND BAKES “Just Like Mother’s”

The little girls will simply “go wild” over these marvelous electric ranges. They can **REALLY** cook and bake—just like mother. The ranges are made in two models, the larger one having two side ovens; the smaller, one large single oven. Both are as efficient for cooking and baking as any large range.

The ovens are large enough for small cakes, pies, potatoes and other dishes. The cooking top is roomy, too. The legs, door frames, cooking tops and shelves of both ranges are heavily nickel-plated. Body is black, japanned. The heating element is designed to give economical operation and an even temperature.

Both ranges are furnished with aluminum utensils—tea kettle, cake and bread pan, skillet, and pie plate. Both operate on standard electric light socket.

An efficient range, of the single oven type. (See general description above.) This model is furnished with three aluminum cooking utensils. No. 3300 Price..... **\$9⁰⁰**

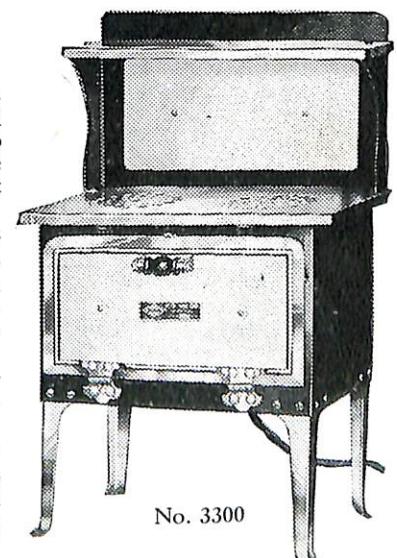

No. 3300

GILBERT **ERECTOR** SETS—

REG. U.S. PAT. OFF.

A Wonderful New Erector—*with Automobile Chassis*

(No. 7½)



Boys, here's a set that will give you the greatest thrill you ever had. It has 627 parts and comes packed in a standard hardwood cabinet, with a 92-page illustrated book telling how to build autos, tractors, scooters, service cars, fire engines, hook and ladder truck—almost everything you can think of. You can build 554 automotive models.

In this marvelous set are included a powerful electric motor, big, red, steel, disc wheels with over-size balloon tires, fenders, radiator hood, bumper, springs, steering wheel, truck body, heavy truck axles, cab top, digger scoop—in fact, everything to make a complete Automotive Erector Set—a unit in itself which will make a wonderful addition to any set you may now own. Price **\$15.00**

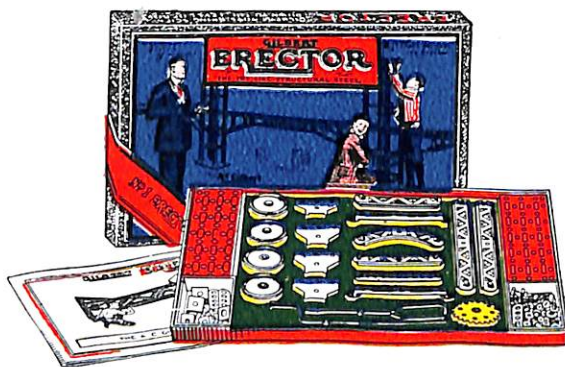

No. 1 ERECTOR A Dandy Beginner's Set

Price
Contains 104 parts. 275 models shown in 20-page manual. **\$1.00**



No. 3 ERECTOR

Price
The set with gears and big red wheels. 169 parts; 381 models shown in 36-page manual **\$3.00**

No. 7 ERECTOR

Contains 473 parts—including powerful electric motor. 533 models shown in 76-page manual. Packed in hardwood cabinet. Price.....

\$10.00



OTHER ERECTOR SETS

There are several other members of the Gilbert Erector Sets family. Each has its specific, useful purpose. All are exceedingly practical and of educational value. They provide endless amusement, combining play with instruction that cannot help but be of utmost value to the youthful mind. Education thus obtained can hardly be figured in dollars and cents.

Naturally, the more elaborate and complete the set, the greater the value, from an educational standpoint. Gilbert Erector Sets retail all the way from one dollar to \$50. We shall be glad to inform you fully about any set in which you may be interested, even if we do not happen to have it in stock. Come in and talk with us about Erector Sets.

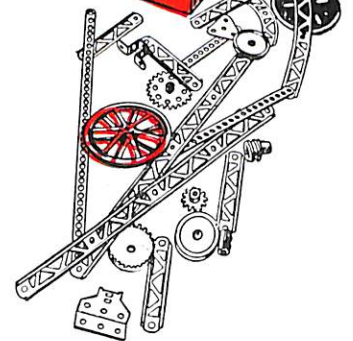

STRUCTO TOYS The All-Year-'Round Toys

PROTECTED BY PATENTS GRANTED OR PENDING.

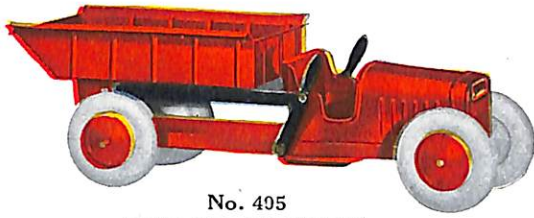

No. 405
DUMP TRUCK

The largest and finest toy of its kind. Very strongly made. Has extra large steel disc wheels. Dumping action controlled by levers at either side of driver's seat. Price... **\$1.25**

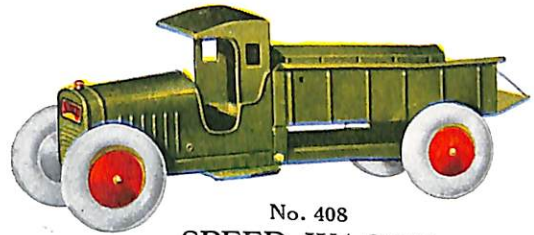

No. 408
SPEED WAGON

Low swung body, chain supported tail-gate, driver's canopy, large disc wheels with painted imitation balloon tires. Of heavy construction; will carry heavy loads. Price. **\$1.25**



No. 406
FIRE TRUCK

Has four extension ladders, which, when placed end upon end, reach almost six feet up in the air. The hose, with its shiny brass nozzle is long enough to more than reach the top rung of the extended ladders. An all-metal truck. Price... **\$1.75**



No. 409
POLICE PATROL

All youngsters like to play "police." Their play is not complete without a Police Patrol—which looks like the real thing. It is all metal; 16½ inches long, 6 inches wide and 6¾ inches high. Price..... **\$1.25**

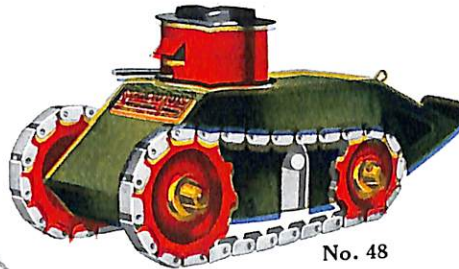

No. 48

WHIPPET WAR TANK

A faithful reproduction of its famous original. Realistic action. Will operate over rough or smooth surfaces. Powerful motor. Revolving turret. This Tank is 12 in. long. All metal construction. Price.. **\$3.00**

SMALL GRAB BUCKET

Like the big ones you see in the sand and gravel pits. Automatic in action, operations being controlled by crank lever. Cab turns on the carriage. Drum mechanism dumps contents of bucket at any desired point. Height, 15 in.; length, 14¾ in. Price..... **\$1.25**

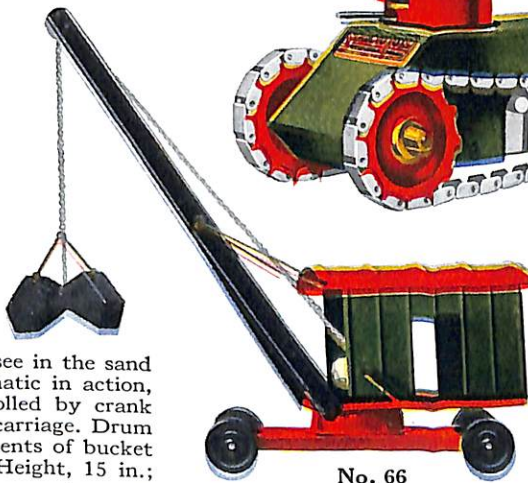

No. 66

STEAM SHOVEL

An outdoor and indoor toy that operates with perfect realism. Its mechanical features are similar to those of the "Small Grab Bucket," except that it has a scoop instead of a grab bucket. Price..... **\$2.00**

PILE DRIVER

No junior construction gang should be without this small reproduction of the man-size pile driver. It works just like the big ones. Price. **\$1.25**

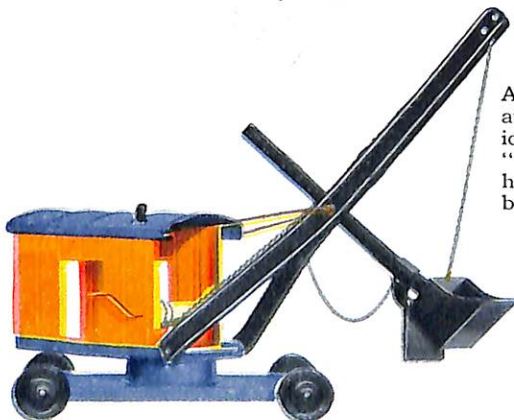

No. 110

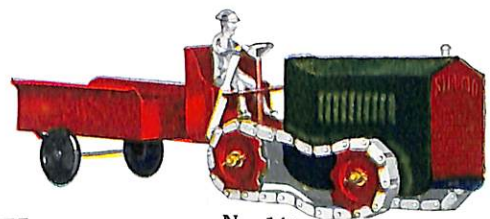

No. 144

CHAIN TREAD TRACTOR AND TRAILER

A powerful tractor that will pull heavy loads, even over rough country. Its spring is exceptionally strong and one winding is sufficient to propel tractor and trailer a goodly distance.

Price..... **\$3.00**



No. 122

American Flyer
Transformers Electricity Trains Mechanical Trains

American Flyer Triple-Action



It seems only yesterday that the boys who are now grandfathers improvised engines and cars out of sawed-off broomsticks, spool-ends and pasteboard boxes. Then came iron trains, but they were rather poor imitations, at best, of the real thing. Yet, it was twenty years ago that the first American Flyer was produced. The first American Flyers were mechanical, or wind-up trains, but they

Mechanically
 and
 Electrically
 Perfect

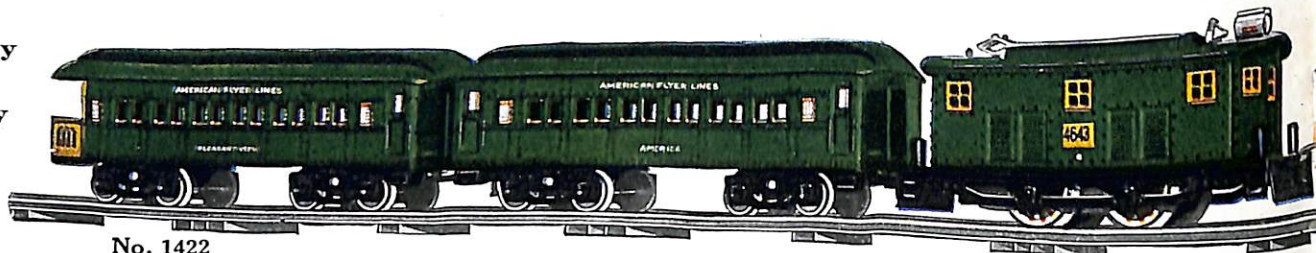

No. 1422

THE EAGLE

A new train especially designed to celebrate the 20th anniversary of the American Flyer. It is 47 inches long; the locomotive itself is 13 1/4 inches long and is fitted with a reverse and a protected headlight with red, green side lenses. The pantagraph, bell and handrails are polished nickel, and the name plate is brass. Each car has an interior electric light and there is a dome light on the observation platform. Track consists of 8 curved pieces and 2 straight ones. The oval is 150 inches circumference. Wide gauge. Price..... \$2000

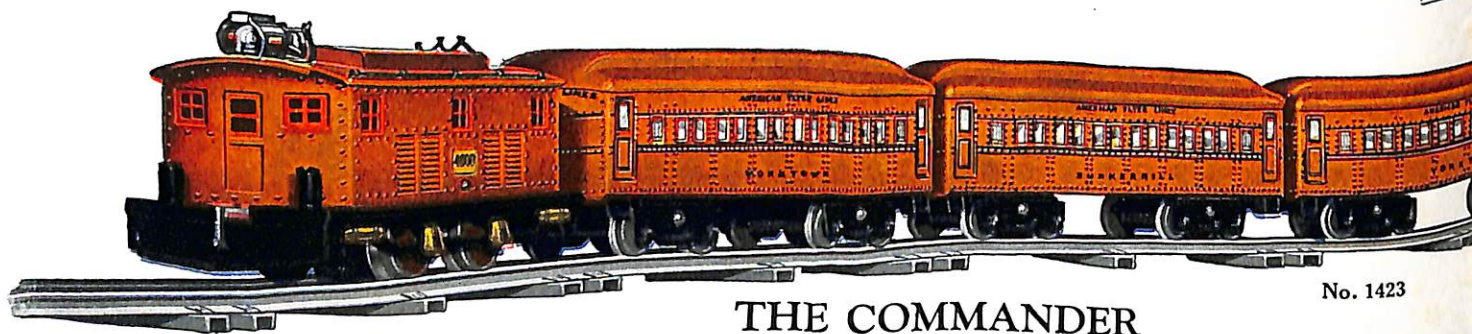

No. 1423

THE COMMANDER

An exceptionally wonderful train. It is 61 inches long and consists of a locomotive, 2 Pullmans and an observation car. The locomotive is 13 1/4 inches long and is equipped with manual reverse and a protected headlight with red and green side lenses. The bell, pantagraph, headlight housing and handrail are all finished in polished nickel, while the name plate, journal boxes and air tank are of brass. The cars are each 14 1/2 inches long, have 1 interior electric light and there is a dome light on the observation platform. Track equipment makes a 184-inch oval. Wide gauge. Price..... \$2700

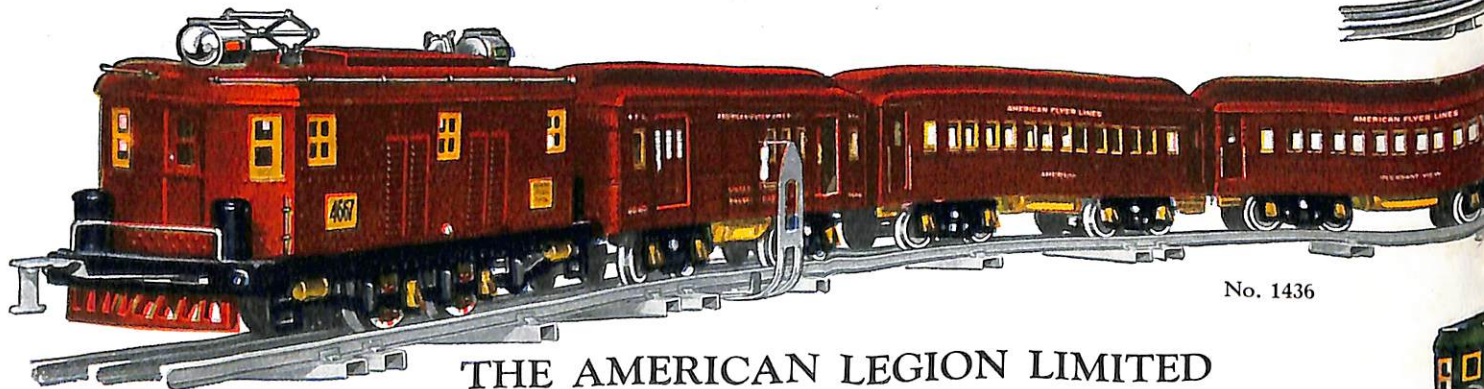

No. 1436

THE AMERICAN LEGION LIMITED

This new, beautifully decorated train is 62 inches long, consisting of locomotive, 15 inches long, combination mail and baggage car, pullman, and observation cars, each 16 inches long, finished in brilliant red. The locomotive has triple action remote control, twin reversible headlights, bell, etc. in polished nickel. Journal boxes, air tanks, etc. are brass. Mail and baggage car has interior lights, sliding doors and mail catcher. Pullman and observation cars have interior electric lights, swinging vestibule doors, and illuminated train sign at rear. Automatic couplers on all cars. Track includes 8 pieces of curved track and 6 straight, with necessary binding clips and terminal connection. Makes a 212-inch oval. Wide gauge. Price..... \$3500

on Remote Control Trains

American Flyer
Transformers Electric Trains Mechanical Trains

ran on tracks, which, for aspiring youth meant a nearer approach to reality. Through the years American Flyer trains have been improved until today they are mechanically and electrically perfect. Many accessories are now available for the boys, such as semaphores, telegraph poles, water tanks, crossing gates, bridges, tunnels, etc.



THE ORIENTAL LIMITED

This train is brilliant in its Oriental yellow. The locomotive has brass journal boxes. There is a combination baggage and mail car, also a Pullman and observation coach. Each has an interior electric light. The cars have double four-wheel trucks and are 6½ inches long. With this train are 8 pieces of curved track, 4 straight pieces of track and two reversed clips, forming a 122-inch oval. "O" gauge. Price..... **\$1075**



The Oriental Limited

No. 1820

THE BLUEBIRD

A very complete outfit, with train, tunnel, semaphore, and station. The locomotive is 9½ inches long, equipped with brass journal boxes, recessed type protected headlight, nickel-plated handrail, bell and pantograph. Cars have double trucks and are 6½ inches long. Passenger and observation cars have 1 interior electric light each. Track consists of 8 pieces curved and 6 pieces straight, forming a 142-inch oval. "O" gauge. Price..... **\$1375**



The Bluebird

No. 1225

THE JEFFERSONIAN

A most realistic electric train. The locomotive is 9½ inches long and has an automatic track reverse. The combination baggage and mail car has 4 sliding doors and 1 interior electric light. The Pullman car has an interior electric light, and the observation car has a light and polished brass railing. All cars are 9½ inches long and are equipped with 4-wheel trucks and brass vestibule steps. The tracks make a 162-inch oval. "O" gauge. Price..... **\$1550**

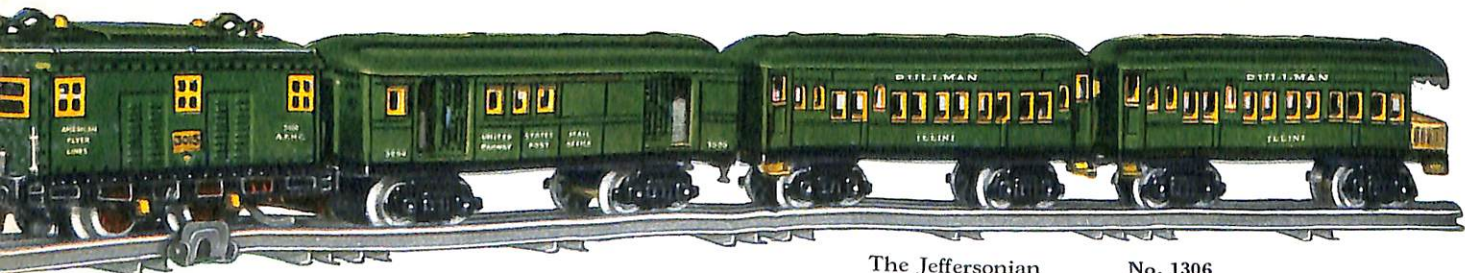
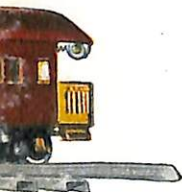

The Jeffersonian

No. 1306



Ted Toys

There never were, and probably never will be, more popular toys for little tots than Ted Toys. They have an instant appeal to "youngsters" of all ages, from 6 months to 80 years. That they are unique and different is apparent from the pictures shown on these pages. But the pictures do not tell the whole story of their popularity. You have to hear the Locomotive "Choo-Choo!" and the Roaring Racer "Putt, Putt!"; see the Acrobat do his stunts and the marchers march, really to appreciate why everybody, young and old, gets a big "kick" out of Ted Toys. Here are shown only a few of the numbers.



No. 1200

TEDDY RED SOLDIER DOLL

A great favorite among babies. It has an elastic cord for bouncing purposes and it will stand in all sorts of amazing positions. Practically unbreakable. Perfectly sanitary.

Price, 60c

GALLOPING JOCKEY

Another lively action toy that has a great appeal to everybody. The horse hasn't the care-free life of Dapple Horse, because he is a thoroughbred that must make a record for his owner, rather than to devote his time to stunts and weird antics. His hoofs can be turned down to clatter like those of a real horse on cobblestones.

Price, \$1.00



No. 1010

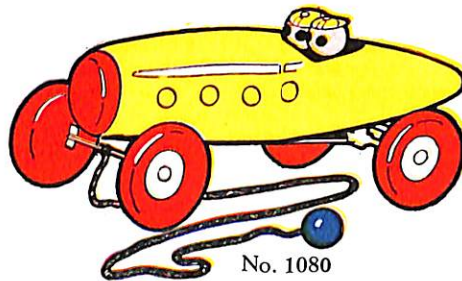

No. 1080

ROARING RACER

Pull this sleek and shiny speedster across the floor and listen to it roar. Its realistic noise will thrill any child and cause a hearty laugh among the elders.

Price, \$1.00

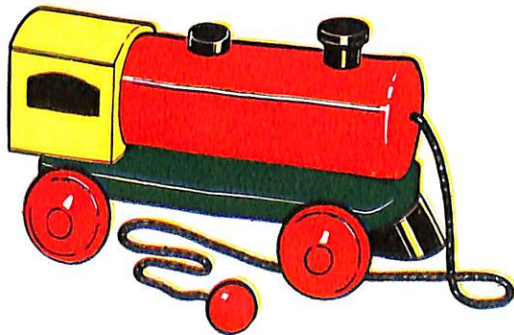

No. 1110

TEDDY LOCOMOTIVE

The little ones can have a lot of fun with this toy and make believe it is a real locomotive—because it "choo-choos" just like one when pulled along the floor. It is 7½ inches long and is sturdily built to endure rough treatment. Price, \$1.00

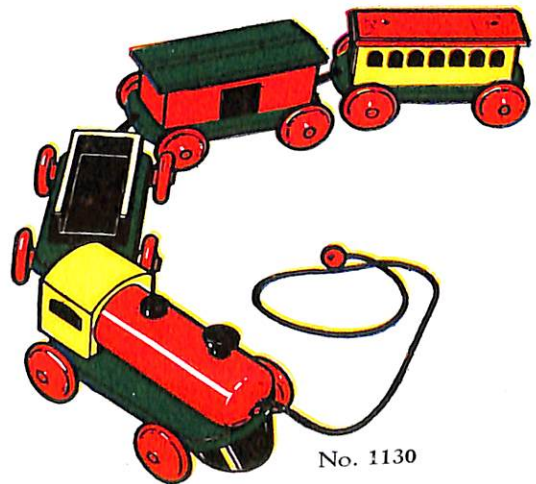

No. 1130

TEDDY TOY TRAIN

The locomotive "choo-choos" and has a coal car. There are a baggage car and passenger coach—all coupled together. The small boys have no end of fun with this train. Price, \$2.50

Ted Toys



Perhaps you are familiar with Ted Toys. Possibly your child or children already have played with these fascinating toys. In either case, you will be interested to know that Ted Toys have recently been considerably improved in construction and finish. Only the finest material and workmanship are used. Colors are best quality lacquer, which will not wash off or come off in children's mouths. Do you know that some of the Ted Toys are made in two sizes? We call them "Regular" and "Giants". For instance, the Regular Dapple Horse is 5¼ inches long and the Giant Dapple Horse is 11 inches long. Ask us about the Giants. Maybe you will prefer them to the Regular.

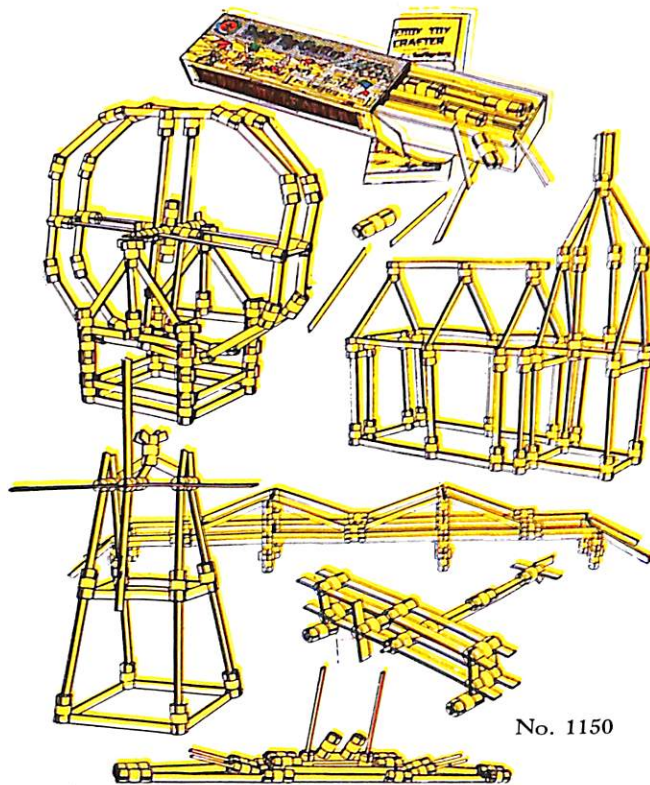

TED TOY CRAFTER

This is a great builder set; simple in form and strong. It comes in an attractive box with a booklet of instructions showing how to build numerous models. It is a wonderful toy for developing creative ability. Innumerable designs can be built; also any letter of the alphabet. The younger children—and even the older ones—will have a lot of fun with this set, testing their cleverness.

Price **50c**



TEDDY DAPPLE HORSE

This wise and winsome steed knows a lot of tricks that a real "flesh-and-blood" couldn't possibly do. He can stand on front legs or hind legs—or only on one at either end! And he can turn his head to look at you, or back over his own body. **SOME HORSE!** You will get a big laugh out of this marvelous steed.

Price..... **60c**

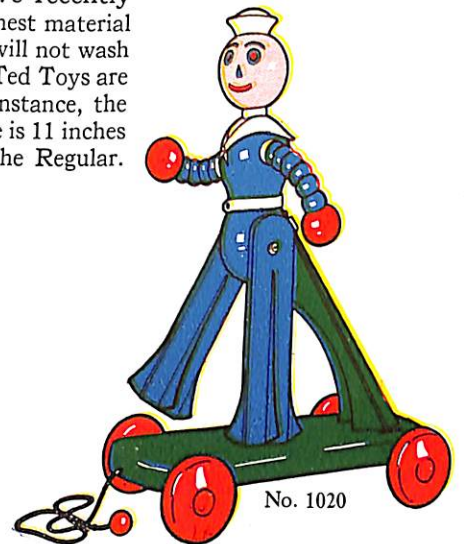

WALKING SAILOR

In his uniform of blue, this "gob" steps out proudly, as if on parade. He amuses and fascinates the children as they pull him along the floor.

Price, **\$1.00**



TEDDY TUMBLING ACROBAT

This jolly clown turns somersaults when you pull him along. He always does them well and comes up smiling.

Price..... **\$1.00**

HUSTLER TOYS for GIRLS and BOYS

A line of mechanical toys that have attained great popularity among "boys" and "girls" of all ages. The infant in arms sits up and "takes notice" when the Hustler Pup barks and Sambo Hustler "does his stuff." Father and Grandpa, not only enjoy the quaint antics of other Hustler toys, but they play the Football and Baseball games with all the interest and enthusiasm of youth. Any one of the Hustler toys and games is a sure-fire joy maker in any household.

Hustler Pup

This pup, when pulled along the floor or sidewalk, moves his legs realistically and barks like a regular dog. The toy is strongly made for long service and the mechanism is so simple that a child would have difficulty in putting it out of commission.

Price, \$1.00



700

Larry Hustler

Larry is a conscientious hard-working jockey whose actions on his thoroughbred are so real that they bring screams of delight from young and old. Well made. Not easily broken.

Price, \$1.00

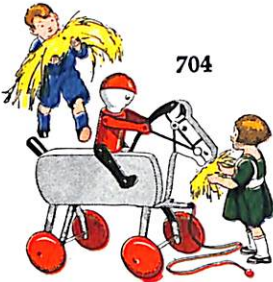

704

Pete Hustler

Pete was one of the first of the Hustler family and his popularity has increased from year to year. He is a truck driver too, like his brother Joe, and his truck is somewhat like Joe's, except that it has only one wheel in front.

Price, \$1.00

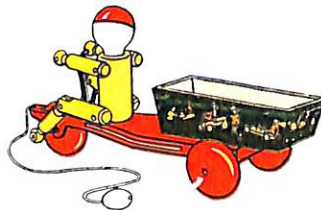

701

Hustler Baseball

Here is a game of baseball that you can play and play right. It is the only game of baseball we know about that comprises all the elements of skill and chance of an actual game. Come in and play it.

Price, \$2.00



100

The Hustler Bell-Hop

In all the hotels you've ever been in, you never saw a bell-hop as "live" and as busy as this one. Every day is his busy day while the kids are around. He swings his grips and hurries about and the kids never tire of watching him. Strong and durable. Metal base.

Price, \$1.00



717

Sambo Hustler

Sambo is as big a laugh getter as Larry, his brother. Sambo drives a balky mule and he surely does have a strenuous, as well as amusing, time getting the 'ole mule to navigate.

Price, \$1.00

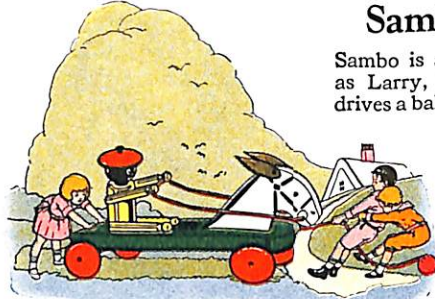

710

Hustler Football

This is a REAL game of football. There is nothing like it on the market. Coach Yost of Michigan has given it his hearty endorsement. Father will get as much enjoyment out of it as the younger generation. Must be inspected carefully in order that you can judge its true worth.

Price, \$2.00



200

Doc Hustler

"Doc" is a silk hat driver, but he believes in speedy service. Hence the classy roadster. Doc is not out after accident cases, so he always is careful enough to turn his head when he rounds sharp corners.

Price, \$1.50

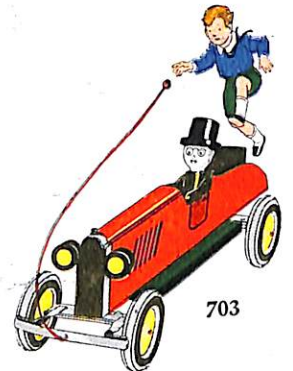

703

Joe Hustler

Joe is another hard working member of the Hustler family, but he never tires of his trucking job. The children use his truck constantly for hauling sand and what-not from morn till night. His truck has a metal body, attractively decorated.

Price, \$1.00



702

The Hustler Duck

Differing from a real, live duck, this bird willingly carries a load of beads or sand and bobs his head back and forth agreeably while doing so.

Price, \$1.25



715

"Sandy Andy" Toys and Games

TRADE MARK REG. U.S. PAT. OFF.

These Toys and Games offer a large variety of attractive, amusing and instructive pastimes. They range from mechanical pull toys to up-to-date fascinating games—all-metal construction.

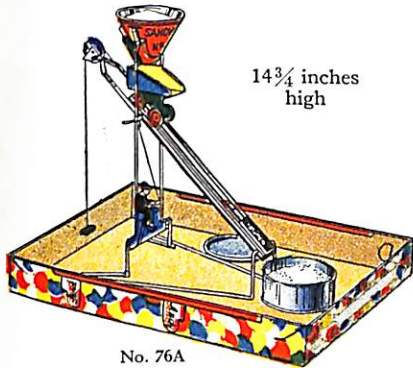

14 3/4 inches high

No. 76A

Incline with Engineer

A larger model of this toy. Faster, more fascinating action. Can of white sand included. Packed in display box which opens flat to form tray.

Price, \$1.00



No. 108

Sandy Andy Merry-Go-Round

Mechanical - Motion Pull Toy

10 in. long, 3 in. wide, 7 in. high. Made entirely of metal, beautifully lithographed. Formed figures without sharp edges. Rubber tire wheels. Action combines sound and movement. Merry-Go-Round turns rapidly while clown rings the bell by hitting it with the hammer. Rapid, continuous action and sound. Packed one in colored display carton.

Price, \$1.00

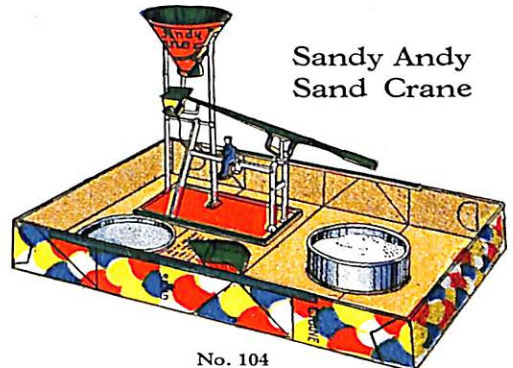

Sandy Andy Sand Crane

No. 104

13 3/8 in. high. Most interesting of all sand toys. Sand runs into shovel; shovel arm swings in semi-circle and engineer dumps the sand. Can of white sand and a sand scoop included. Packed in display box which opens flat to form tray.

Price, \$1.25



No. 1A

4-Piece Set

Contains metal washtub 4 3/4 x 10 in., blue enamel outside, white inside; clothes reel, glass surface washboard 5 1/2 x 11 in., and bundle of six clothespins. Complete set packed in carton.

Price, \$1.00



No. 38

Speed Boat Race

Motor Boat Race Game complete with checkerboard and checkers. Four speed boats race over a regular course encountering the hazards of a real race. An exciting game for all children. Four boats included. Board is 16 1/2 in. square. Packed in display box.

CHECKERBOARD ON REVERSE SIDE OF EACH GAME. BOX OF 24 EMBOSSED CHECKERS INCLUDED.

Price, \$1.00



No. 29

The Motor Race

Automobile Race Game complete with checkerboard and checkers. Four automobiles race around the speedway, spinning dials indicating moves. A fast-action lively game for little folks. Four automobiles included. Board 16 1/2 in. square. Packed in display box.

Price, \$1.00

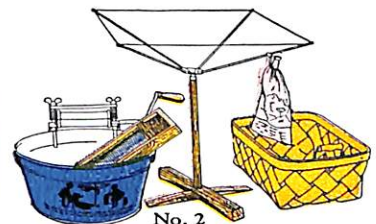

No. 2

6-Piece Set

Contains metal washtub 4 3/4 x 10 in., blue enamel outside, white inside; clothes reel; glass surface washboard 5 1/2 x 11 in.; 12 clothespins in bag; galvanized wringer with rubber rollers; and clothes basket. Complete in carton.

Price, \$2.50

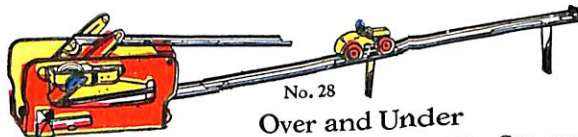

No. 28

Over and Under

Wonderful mechanical toy; perfect working motor. Car runs down upper incline, drops to lower track and continues to end; then reverses to opposite end, where motor raises car for another trip. Action repeats many times with one winding. 25 inches long.

Price, \$1.00



Bowler Andy Mill
21 inches high. Automatic Marble Toy. Car travels up and down and windmill turns continually. Eight steel marbles included.

Price, \$1.50

No. 57A

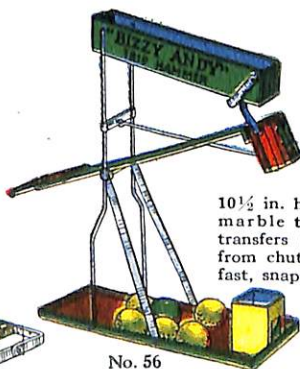

Bizzy Andy Trip Hammer

10 1/2 in. high. Automatic marble toy. Hammer transfers 6 clay marbles from chute to base with fast, snappy action; marbles included.

Price, 50c

No. 56

Bizzy Andy Junior

7 in. high. Automatic marble toy and game. Swinging arm carries marble to base. 8 clay marbles included.

Price 25c

No. 58

Panama Pile Driver

16 3/4 inches high. Automatic Marble Toy. Hammer and "engineer" both move up and down rapidly. Realistic pile driver action; 8 steel marbles included. Price, \$1.25

No. 54

★ ★ ★ STAR LINE GAMES ★ ★ ★

Some New Games that Both Amuse and Educate
the Children While They Play

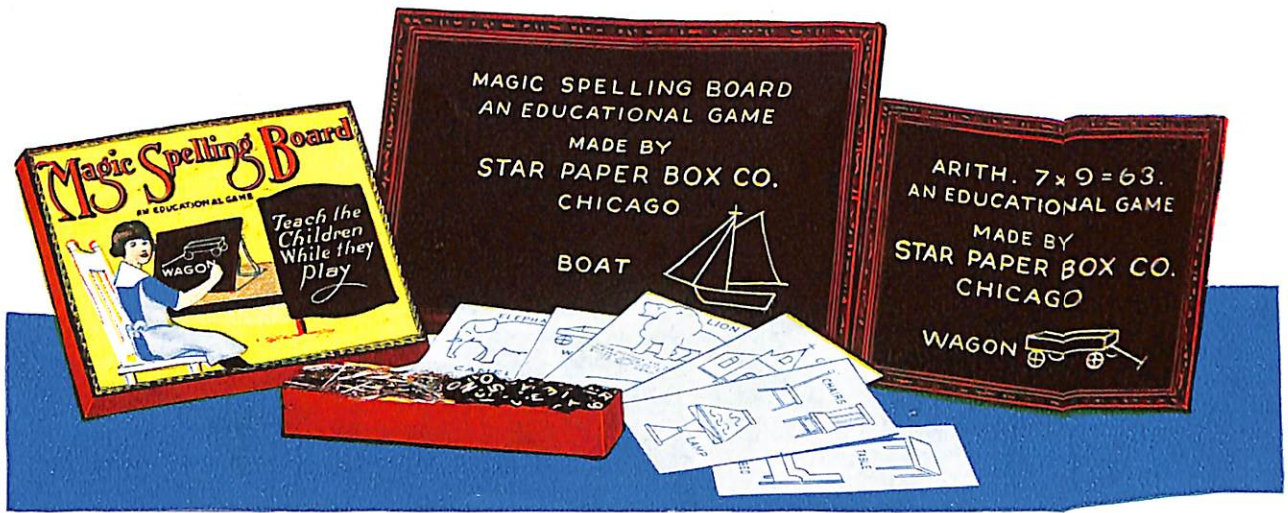

MAGIC SPELLING BOARD

This is one of the cleverest games ever conceived. Just place a letter, numeral or a wire where you want it and it stays there. It won't drop off. Letters and other units are metal. Under the blackboard is a Small size, 8½x10 inches—No. 1800.
Price..... \$250

heavy, well-made magnet that will last for years. Made in two sizes, each containing 252 letters, numerals, wires, and 12 pictures with which to pattern on to the board. All fit compactly into an illustrated container. Large size, 10x15 inches—No. 1801.
Price..... \$400



No. 375

INDOOR HORSESHOE

A miniature adaptation of the great national sport. The children, father and grandpa will play it with equal zest. Container, as shown by the illustration, has two pegs securely anchored. The horseshoes are made of white metal and are 1½ inches wide and 2 inches long.

Price 50c

BASKETBALL

Young and old will find this game most interesting. The ball is placed in the runway. Plunger is pulled and released. Ball is driven around and over the jump into the playing area. It goes into the basket or it may fall into the other pockets. Full set of rules and instructions with each game. Made of metal and comes in an attractive container.
Price..... \$100



No. 775

Both Young and Old Will Enjoy These Games

IN ALL THE WORLD THERE ARE NO BETTER SLEDS THAN THESE

—For Speed—Safety—and Long Life

If you want a speedy, easily steered sled, the ones shown on this page have all others "beaten a mile." And we don't mean "Maybe!" They go—and they go FAST! Also, they are built to

last a lifetime. Every detail of construction has been studied out by engineers who were "boys once, themselves," and, so, know what the hill burners demand in both speed and safety.

Hibbard GLIDER

Every line is built for speed. The runners are of the flat running surface kind, made of high-carbon spring steel. The other parts are of heavy gauge stamped steel and of air-dried selected white ash wood. Finished in three coats of high-grade coach varnish. Boys—here's a REAL sled!

Price \$195

Let's Go!

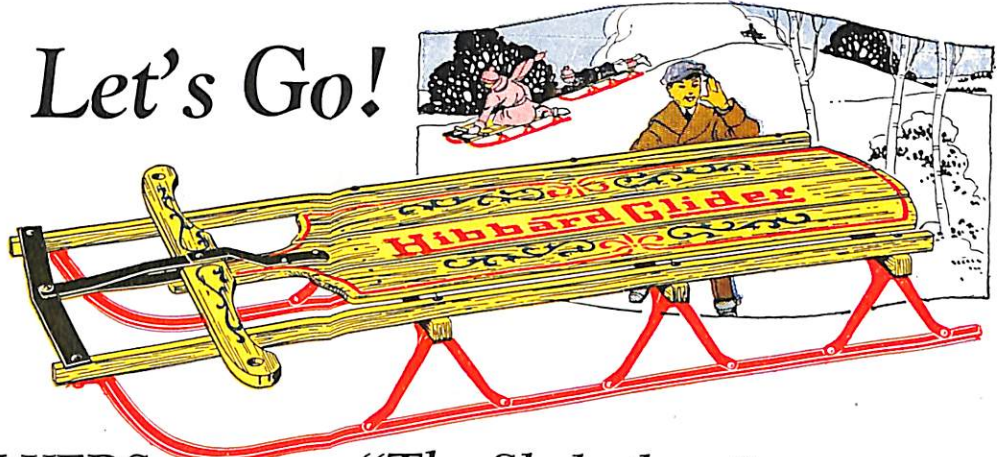

FLEXIBLE FLYERS "The Sleds that Steer"

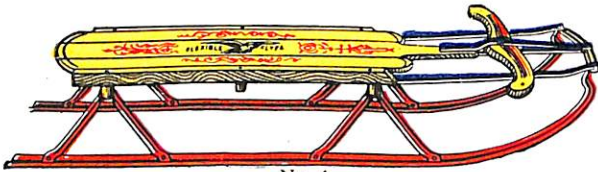

No. 4

Every boy knows the "Flexible Flyer." It's just a question of which one he prefers. And the girls know them, too. So do the parents, because these sleds provide for safety steering. The runners are grooved. The one above is 38 inches in length, 6 inches high and 12 inches wide. Price \$650

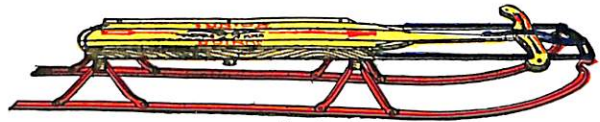

No. 6

This is a smaller model of the Flexible Flyers shown above. It is only 49 inches long, 5 1/4 inches high (in the rear), and 6 1/4 inches high (in the front). Note its "rakish" lines. A most appropriate sled for the youngest coasters. Price \$525

Another model that is similar in every way to No. 4, except that it is 63 inches long, 8 inches high and 16 inches wide. All steel parts are japanned—not merely painted and varnished, so the colors stay "put." Price \$875



No. 5

SLED AND WAGON GUARD

Illustration shows a new safety attachment which can be easily affixed to sleds and coaster wagons. It straps on any size or make of sled and no screws or nails are needed. The back can be reclined to any comfortable position. It is made in one size only. Back, 14 inches high; side, 24 inches long, and 7 inches high. Rigidly constructed of white ash lumber and finished with two coats of weather varnish.

Price \$150

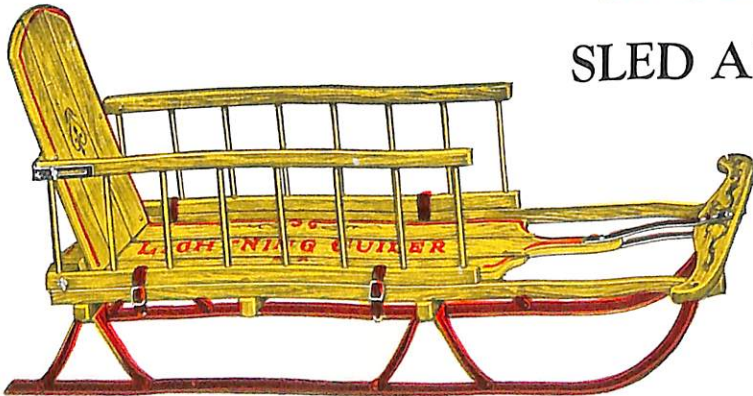

STRONGLY MADE ~ BUILT TO LAST

Ann Drock SNO-CAP Toy Sets



No. 4

Cake Turner
Kitchen Spoon

Egg Beater
Tea Strainer

This is a thoroughly practical little set; well made, strong, and so made that the tools cannot possibly injure little fingers. Price 50c

The kitchen set shown at the right is more complete than the one above, but the tools are similarly made—with the same precision and care which have made "Androck" famous. Both are put up in boxes that especially appeal to the little girls. This set comprises the utensils listed and is priced most reasonably for this pre-Christmas sale. Price \$1.00



No. 400

Pastry Board
Rolling Pin
Potato Masher

Cookie Pan
Tea Strainer
Club Cookie Cutter

Egg Beater
Cake Turner
Kitchen Spoon



Safe, Sanitary Blocks



These are the kind of blocks you played with when a child; and so did your father and mother. Of course, there have been improvements in design and sanitary features—in keeping with the times: but the blocks are practically the same, as you can see from the illustrations.



No. 330

An incomparable set which comprises embossed letters; stamped numerals and pictures of animals, etc., with names of same. This set has 30 blocks, in four colors. Rounded corners. Price \$1.00



No. 316

Another set, similar to the one shown at the left. Blocks are made of finest hardwood; perfectly embossed. Rounded corners, to obviate harm to the little tots. This set comprises 16 blocks, in four colors. Price 50c

THE FINEST of DOLL CARRIAGES

These Meinecke doll carriages are immensely popular among the little girls, because they are made just like the carriages in which the children rode when infants. We show here only 4 types that we are especially pricing at this

time. The Meinecke line is a large one, and if you do not see here just what you want, we shall be glad to order your preference from the catalogue which you can look over in our store, at your convenience.



No. 108

Body 8 inches wide, 16 inches long, 20 inches high to top of hood, 20 inches high to top of handle. $6 \times \frac{1}{2}$ -inch double spoke rubber tire wheels with nickel-plated hub caps. Finished in Cafe. Loom woven flat fibre.

Price \$250



No. 111

Body 8 inches wide, $18 \frac{1}{2}$ inches long, 22 inches high to handle, $24 \frac{1}{2}$ inches high to top of hood. $7 \times \frac{5}{16}$ -inch double spoke rubber tire wheels with nickel-plated hub caps. Finished in Blue. Loom woven flat fibre.

Price \$350



No. 246

Loom woven round fibre. Seat, back, half sides and hood lined in imitation corduroy. Body $20 \frac{1}{2}$ inches long, $24 \frac{1}{2}$ inches long, reclining; 12 inches wide; 30 inches to top of hood; 24 inches to handle; $8 \times \frac{3}{8}$ -inch double spoke, rubber tire wheels with nickel-plated hub caps. Finished in Carmel Color.

Price \$850



No. 123

Loom woven flat fibre with round fibre rolls. Body 19 inches long, 9 inches wide, 25 inches to top of hood, 23 inches to handle, $7 \times \frac{5}{16}$ -inch double spoke rubber tire wheels with nickel-plated hub caps. Finished in Cafe.

Price \$500

Every Little Girl Loves a Doll Carriage and Especially Such Real and Attractive Ones As These. Order Yours Early.

JOHNSONS

America's Favorite Ice Skates

In the past thirty years all winners in every national, international and professional speed skating championship events have used all-steel, full tubular skates. As one international champion said, "To me, Johnsons have life, power, balance and spring. Others I have tried seemed dead."

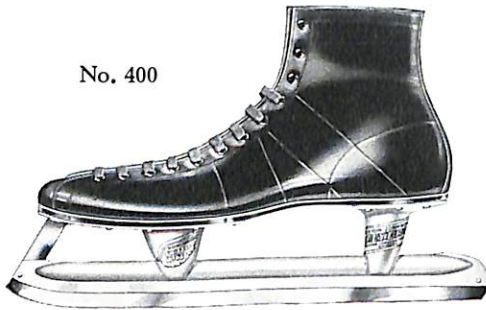

No. 400

NESTOR JOHNSON FLYERS

MEN'S HOCKEY

This is one of the famous Nestor Johnson Flyers. The skates are firmly riveted to shoes, set in correct scientific position. Welded throughout with seamless cups of one piece drawn, and high carbon steel blades. Blades rockered for turning on small radius. Aluminum finish. Complete with shoes. Racing skates also made in same grade. Shoe sizes, 1 to 12.

Price \$750

NESTOR JOHNSON FLYERS

LADIES' HOCKEY

Because they are both light and strong, Nestor Johnson "Flyers" give ladies the skating ease and security which begets confidence. Johnson's are actually the easiest skates on which to learn, and their handsome appearance gives an added grace to skating. May be had in racing shape of same grade. Shoe sizes, 1 to 9.

Price \$750

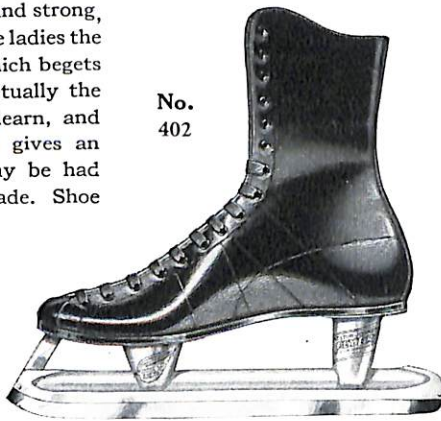

No. 402



NESTOR JOHNSON NORTH STAR

MEN'S RACER

A perfectly balanced skate, attached to the shoe in correct scientific position. That means easier mastery of the skates and the development of great speed. A real racing skate at a moderate price. Also made in Ladies' Racers and in hockey shape for men and women. Shoe sizes, 1 to 12.

Racers and in hockey shape for men and women. Shoe sizes, 1 to 12.

Price \$1100

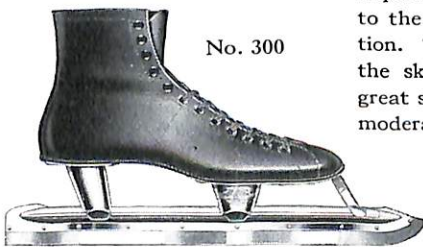

No. 300

"They Go Like Lightning"



AMERICA'S FIRST TUBULAR SKATE

The first pair of tubular skates made in the United States or Canada were made in Chicago by Nestor Johnson. The fundamental principles of JOHNSON skates have remained the same since the original pair were finished. Their all-steel, full tubular construction has won fame all over the world.

Better Health ~ Greater Pleasure



Children—You May Send Your Letters to Santa Claus to This Store.

We are doing our best to help Santa Claus make this the merriest of Christmas Days.

We will try to see that Santa Claus gets every letter that you send to him in care of this store. Merry Christmas to You, Again!

SANTA CLAUS has opened his bag of toys. You have seen what he has to offer the children. But he has not shown or told you about the many, varied gifts we have on display at this time. They range all the way from toys and tools to highest-grade silverware.

We suggest that you come in early and inspect the many items of both luxury and utility that we are showing and pricing at pre-season valuations.

There are suitable presents for every member of the family and all your friends and relatives. There are many gifts that will delight mother, father, son and daughter, and so on down the line to casual acquaintances to whom you may be under obligation.

Knowing that we can carry only a limited stock, you should improve this opportunity by coming in at once, before the “plums” are picked—before necessity demands that we replenish our stock at higher costs to us, and in turn, to you.

Briefly, “do your Christmas shopping early”—not alone to “avoid the rush,” but to take advantage of the bargains and selections now available.

As you doubtless know, we offer only highest quality goods at prices that are RIGHT. If we haven't exactly what you want we shall be glad to order it for you, and have it in your hands before Christmas—if you come in early!

